

**FISHER & PAYKEL**

**MICROWAVE OVEN**

---

MO-24SS models

**INSTALLATION GUIDE / USER GUIDE**

**US CA**

## FOR CUSTOMER ASSISTANCE

---

To aid in reporting this microwave oven in case of loss or theft, record below the model number and serial number located on the unit. We also suggest you record all the information listed and retain for future reference.

**Model Number** \_\_\_\_\_ **Serial Number** \_\_\_\_\_

**Date of Purchase** \_\_\_\_\_

**Dealer** \_\_\_\_\_ **Telephone** \_\_\_\_\_

**Service** \_\_\_\_\_ **Telephone** \_\_\_\_\_

### **Before you call for service or assistance ...**

Check the things you can do yourself. Refer to the installation instructions and your user guide and check that:

- 1 your product is correctly installed
- 2 you are familiar with its normal operation.

If after checking these points you still need assistance or parts, refer to the Service & Warranty book for warranty details and your nearest Authorized Service Center, or contact us through our website [www.fisherpaykel.com](http://www.fisherpaykel.com).

## **PRECAUTIONS TO AVOID POSSIBLE EXPOSURE TO EXCESSIVE MICROWAVE ENERGY**

- a) Do not attempt to operate this oven with the door open since open-door operation can result in harmful exposure to microwave energy. It is important not to damage or tamper with the safety interlocks.
- b) Do not place any object between the oven front face and the door or allow soil or cleaner residue to accumulate on sealing surfaces.
- c) Do not operate the oven if it is damaged. It is particularly important that the oven door close properly and that there is no damage to the:
  - 1) door (bent)
  - 2) hinges and latches (broken or loosened)
  - 3) door seals and sealing surfaces.
- d) The oven should not be adjusted or repaired by anyone except properly qualified service personnel.

# CONTENTS

---

<b>For Customer Assistance</b> .....	<b>1</b>		
<b>Precautions to Avoid Possible Exposure to Excessive Microwave Energy</b> .....	<b>1</b>	Quick Recipes Recipes.....	19-20
<b>Contents</b> .....	<b>2</b>	Defrost .....	21-22
<b>Important Safety Instructions</b> .....	<b>3</b>	Super Defrost Chart.....	21
<b>Unpacking and Installation Instructions</b> .....	<b>4-5</b>	Defrost Chart .....	22
<b>Grounding Instructions</b> .....	<b>5</b>	Beverage .....	23
<b>Information You Need to Know</b> .....	<b>6-8</b>	Beverage Chart .....	23
About Your Oven.....	6	<b>Other Convenient Features</b> .....	<b>24-26</b>
About Food .....	6	Keep Warm .....	24
About Utensils and Coverings.....	7	Multiple Sequence Cooking.....	24
About Children and the Microwave .....	7	More or Less Time Adjustment.....	24
About Microwave Cooking.....	8	Help Menu .....	25
About Safety .....	8	1. Child Lock	
<b>Part Names</b> .....	<b>9</b>	2. Audible Signal Elimination	
<b>Before Operating</b> .....	<b>10</b>	3. Auto Start	
<b>Manual Operation</b> .....	<b>11</b>	4. Language/Weight Selection	
<b>Sensor</b> .....	<b>12-15</b>	5. Clock On/Off	
Sensor Chart .....	13-14	Help .....	25
Sensor Recipes .....	14-15	Timer/Clock.....	26
<b>Other Cooking Features</b> .....	<b>16-23</b>	Extra Minute.....	26
Breakfast Menu and Lunch Menu .....	16	Start.....	26
Breakfast Menu Chart.....	16-17	Demonstration Mode.....	26
Lunch Menu Chart.....	17	<b>Cleaning and Care</b> .....	<b>27</b>
Dinner Menu and Quick Recipes .....	18	<b>Specifications</b> .....	<b>28</b>
Dinner Menu Recipes .....	18-19	<b>Service Call Check</b> .....	<b>28</b>
		<b>Warranty</b> .....	<b>29</b>
		<b>Control Panel Guide</b> .....	<b>30-31</b>

## INTERACTIVE COOKING SYSTEM

The Interactive Cooking System offers step-by-step instructions in the display for using the oven, from setting the clock to programming each feature. It also includes HELP MENU for instructions on using Child Lock, Audible Signal Elimination and Auto Start. There is a choice of English, Spanish or French and a choice of U.S. Customary Unit-pound or Metric-kilograms. Touch HELP MENU and follow the directions displayed or check page 25.

## IMPORTANT SAFETY INSTRUCTIONS

When using electrical appliances basic safety precautions should be followed, including the following:

**WARNING:** To reduce the risk of burns, electric shock, fire, injury to persons or exposure to excessive microwave energy:

- 1. READ ALL INSTRUCTIONS BEFORE USING THE APPLIANCE.**
2. Read and follow the specific '**PRECAUTIONS TO AVOID POSSIBLE EXPOSURE TO EXCESSIVE MICROWAVE ENERGY**' on inside front cover.
3. This appliance must be grounded. Connect only to properly grounded outlet. See '**GROUNDING INSTRUCTIONS**' on page 5.
4. Install or locate this appliance only in accordance with the provided installation instructions.
5. Some products such as whole eggs and sealed containers—for example, closed glass jars—are able to explode and should not be heated in this oven.
6. Use this appliance only for its intended use as described in this manual. Do not use corrosive chemicals or vapors in this appliance. This type of oven is specifically designed to heat, cook or dry food. It is not designed for industrial or laboratory use.
7. As with any appliance, close supervision is necessary when used by children.
8. Do not operate this appliance if it has a damaged cord or plug, if it is not working properly or if it has been damaged or dropped.
9. This appliance should be serviced only by qualified service personnel. Contact nearest Authorized Servicer for examination, repair or adjustment.
10. Do not cover or block any openings on the appliance.
11. Do not store or use this appliance outdoors. Do not use this product near water—for example, near a kitchen sink, in a wet basement, near a swimming pool, or similar locations.
12. Do not immerse cord or plug in water.
13. Keep cord away from heated surfaces.
14. Do not let cord hang over edge of table or counter.
15. See door surface cleaning instructions on page 27.
16. To reduce the risk of fire in the oven cavity:
  - a. Do not overcook food. Carefully attend to appliance when paper, plastic or other combustible materials are placed inside the oven to facilitate cooking.
  - b. Remove wire twist-ties from paper or plastic bags before placing bag in oven.
  - c. **If materials inside the oven ignite, keep oven door closed, turn oven off and disconnect the power cord or shut off power at the fuse or circuit breaker panel.**
  - d. Do not use the cavity for storage purposes. Do not leave paper products, cooking utensils or food in the cavity when not in use.
17. Liquids, such as water, coffee or tea are able to be overheated beyond the boiling point without appearing to be boiling. Visible bubbling or boiling when the container is removed from the microwave oven is not always present. **THIS COULD RESULT IN VERY HOT LIQUIDS SUDDENLY BOILING OVER WHEN A SPOON OR OTHER UTENSIL IS INSERTED INTO THE LIQUID.** To reduce the risk of injury to persons:
  - a. Do not overheat the liquid.
  - b. Stir the liquid both before and halfway through heating it.
  - c. Do not use straight-sided containers with narrow necks. Use a wide-mouthed container.
  - d. After heating, allow the container to stand in the microwave oven at least for 20 seconds before removing the container.
  - e. Use extreme care when inserting a spoon or other utensil into the container.
18. If the oven is installed as a built-in, observe the following instructions:
  - a. Do not mount over a sink.
  - b. Do not store anything directly on top of the appliance surface when the appliance is in operation.
19. If the oven light fails, consult an AUTHORIZED SERVICER.

## SAVE THESE INSTRUCTIONS

# UNPACKING AND INSTALLATION INSTRUCTIONS

## Unpacking and examining your oven

Remove: all packing materials from inside the oven cavity; however, **DO NOT REMOVE THE WAVEGUIDE COVER**, which is located on the right cavity wall. Read enclosures and **SAVE** this manual.

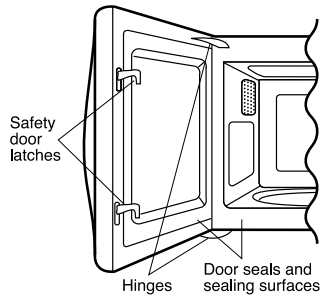

Check the oven for any damage, such as misaligned or bent door, damaged door seals and sealing surfaces, broken or loose door hinges and latches and dents inside the cavity or on the door. If there is any damage, do not operate the oven and contact your dealer or **AUTHORIZED SERVICER**.

## Choosing a location for your oven on the counter

You will use the oven frequently so plan its location for ease of use. It's wise, if possible, to have counter space on at least one side of the oven. Allow at least 2 inches on the sides, top and at the rear of the oven for air circulation.

## Choosing a location for your oven if built-in

Your oven can be built into a cabinet or wall by itself or above the models listed below using a Fisher & Paykel branded or Fisher & Paykel branded Microwave Accessory Trim Kit (MOTTK). To order the Trim Kit, contact Customer Care.

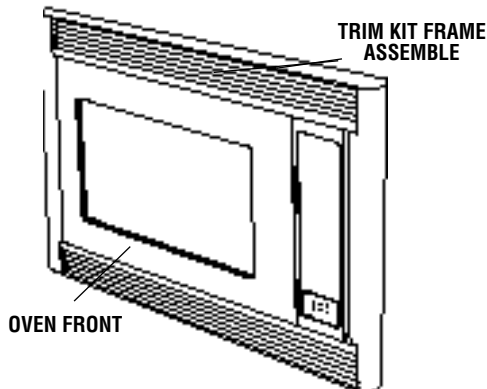

**Fisher & Paykel models above which the MO24-SS microwave oven can be built in:**

**Ovens:** WOSU-30  
OB30SDEPX

**Warming drawers:** WDU-30  
WDUI-30  
OD30WDX1

**Do not build in above any other gas or electric wall oven.**

## Over oven installation

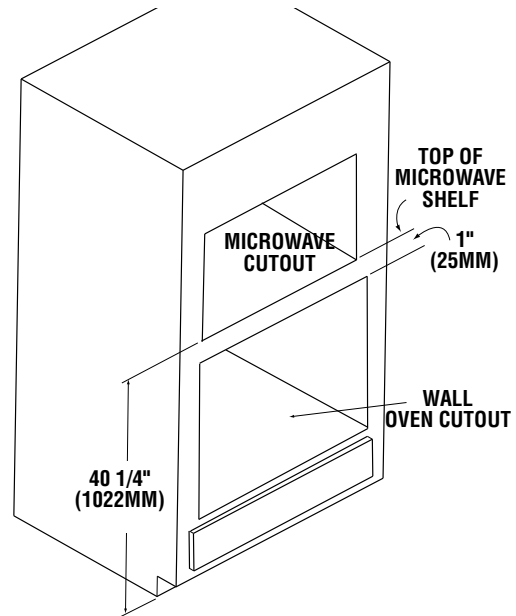

## Over warming drawer installation

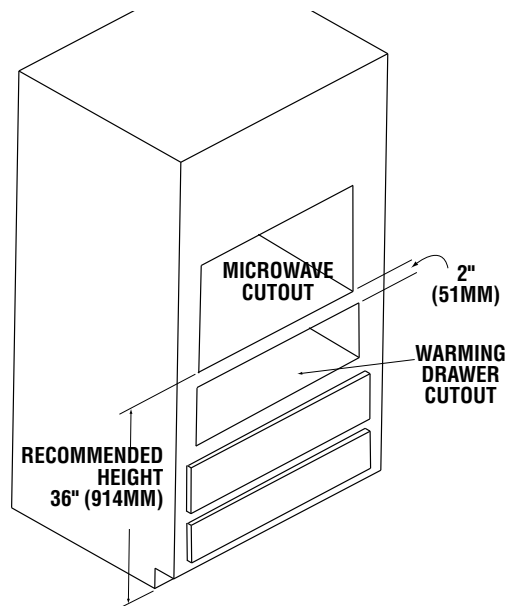

See Trim Kit Installation Instructions for proper location when building in above the specified wall ovens. Carefully follow both the wall oven installation instructions and Trim Kit instructions.

The opening in the wall or cabinet must be within the following dimensions:

- A HEIGHT** :  $17" + \frac{1}{16}"$ , -0
- B WIDTH** :  $24 \frac{3}{4}" + \frac{1}{16}"$ , -0
- C DEPTH** : minimum 20"

# UNPACKING AND INSTALLATION INSTRUCTIONS

Outlet should NOT be in the shaded area as indicated.

1. If the dimension of DEPTH (C) is more than 21", the outlet location may be any area on the rear wall.
2. The floor of the opening should be constructed of plywood strong enough to support the weight of the oven and floor load (about 100 pounds).

The floor should be level for proper operation of the oven. Be sure to check the local building code as it may require that the opening be enclosed with sides, ceiling and rear partition. The proper functioning of the oven does not require the enclosure.

The Trim Kit includes all the necessary parts (including simulated frames that match the MO-245S microwave oven) and easy-to-follow instructions for installation as well as location of the power supply.

The ease of assembly for these kits will allow installation into an existing wall opening in less than an hour (if power outlet is already properly located). All it takes are four steps and a Phillips screw driver.

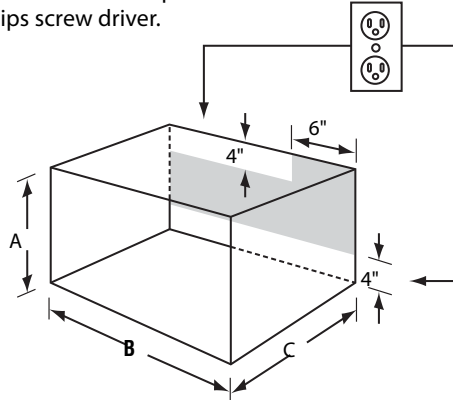

## GROUNDING INSTRUCTIONS

This appliance must be grounded. This oven is equipped with a cord having a grounding wire with a grounding plug. It must be plugged into a wall receptacle that is properly installed and grounded in accordance with the National Electrical Code and local codes and ordinances. In the event of an electrical short circuit, grounding reduces risk of electric shock by providing an escape wire for the electric current.

**WARNING:** Improper use of the grounding plug can result in a risk of electric shock.

### Electrical requirements

The electrical requirements are a 120 volt 60 Hz, AC only, 15 amp. or more protected electrical supply. It is recommended that a separate circuit serving only this appliance be provided.

The oven is equipped with a 3-prong grounding plug. It must be plugged into a wall receptacle that is properly installed and grounded. Should you only have a 2-prong outlet, have a qualified electrician install a correct wall receptacle.

A 3-prong adapter may be purchased and used temporarily if local codes allow. Follow package directions.

A short power-supply cord is provided to reduce risk of becoming entangled in or tripping over a longer cord.

### Extension Cord

If it is necessary to use an extension cord, use only a 3-wire extension cord that has a 3-blade grounding plug and a 3-slot receptacle that will accept the plug on the microwave oven. The marked rating of the extension cord should be AC 115-120 volt, 15 amp. or more.

Be careful not to drape the cord over the countertop or table where it can be pulled on by children or tripped over accidentally.

Notes:

1. If you have any questions about the grounding or electrical instructions, consult a qualified electrician or service person.
2. Fisher & Paykel nor the dealer can accept any liability for damage to the oven or personal injury resulting from failure to observe the correct electrical connection procedures.

### Radio or TV Interference

Should there be any interference caused by the microwave oven to your radio or TV, check that the microwave oven is on a different electrical circuit, relocate the radio or TV as far away from the oven as feasible or check position and signal of receiving antenna.

#### Permanent and Correct Installation

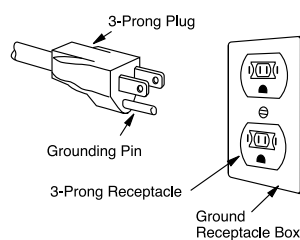

#### Temporary Use

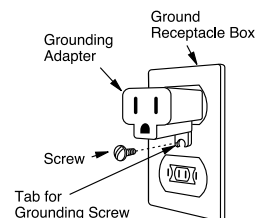

## INFORMATION YOU NEED TO KNOW

---

### ABOUT YOUR OVEN

This manual is valuable: read it carefully and always save it for reference.

A good microwave cookbook is a valuable asset. Check it for microwave cooking principles, techniques, hints and recipes.

**NEVER** use the oven without the turntable and support nor turn the turntable over so that a large dish could be placed in the oven. The turntable will turn both clockwise and counterclockwise.

**ALWAYS** have food in the oven when it is on to absorb the microwave energy.

When using the oven at power levels below 100%, you may hear the magnetron cycling on and off. It is normal for the exterior of the oven to be warm to the touch when cooking or reheating.

Condensation is a normal part of microwave cooking. Room humidity and the moisture in food will influence the amount of moisture that condenses in the oven. Generally, covered foods will not cause as much condensation as uncovered ones. Vents on the oven back must not be blocked.

The oven is for food preparation only. It should not be used to dry clothes or newspapers.

Your oven is rated 1200 watts by using the IEC Test Procedure. In using recipes or package directions, check food a minute or two before the minimum time and add time accordingly.

### ABOUT FOOD

FOOD	DO	DON'T
<b>Eggs, sausages, nuts, seeds, fruits &amp; vegetables</b>	<ul style="list-style-type: none"> <li>• Puncture egg yolks before cooking to prevent 'explosion'.</li> <li>• Pierce skins of potatoes, apples, squash, hot dogs and sausages so that steam escapes.</li> </ul>	<ul style="list-style-type: none"> <li>• Don't cook eggs in shells.</li> <li>• Don't use SENSOR REHEAT for whole eggs. Don't dry nuts or seeds in shells.</li> </ul>
<b>Popcorn</b>	<ul style="list-style-type: none"> <li>• Use specially bagged popcorn for the microwave oven.</li> <li>• Listen while popping corn for the popping to slow to 1 or 2 seconds or use special <b>Popcorn</b> pad.</li> </ul>	<ul style="list-style-type: none"> <li>• Don't pop popcorn in regular brown bags or glass bowls.</li> <li>• Don't exceed maximum time on popcorn package.</li> </ul>
<b>Baby food</b>	<ul style="list-style-type: none"> <li>• Transfer baby food to small dish and heat carefully, stirring often. Check temperature before serving.</li> <li>• Put nipples on bottles after heating and shake thoroughly. 'Wrist' test before feeding.</li> </ul>	<ul style="list-style-type: none"> <li>• Don't heat disposable bottles.</li> <li>• Don't heat bottles with nipples on.</li> <li>• Don't heat baby food in original jars.</li> </ul>
<b>General</b>	<ul style="list-style-type: none"> <li>• Cut baked goods with filling after heating to release steam and avoid burns.</li> <li>• Stir liquids briskly before and after heating to avoid 'eruption'.</li> <li>• Use deep bowl, when cooking liquids or cereals, to prevent boilovers.</li> </ul>	<ul style="list-style-type: none"> <li>• Don't heat or cook in closed glass jars or air tight containers.</li> <li>• Don't heat cans in the microwave as harmful bacteria may not be destroyed.</li> <li>• Don't deep fat fry.</li> <li>• Don't Dry wood, gourds, herbs or wet papers.</li> </ul>

## INFORMATION YOU NEED TO KNOW

---

### ABOUT UTENSILS AND COVERINGS

It is not necessary to buy all new cookware. Many pieces already in your kitchen can be used successfully in your new microwave oven. Make sure the utensil does not touch the interior walls during cooking.

#### Use these utensils for safe microwave cooking and reheating:

- glass ceramic (Pyroceram®), such as Corningware®.
- heat-resistant glass (Pyrex®)
- microwave-safe plastics
- paper plates
- microwave-safe pottery, stoneware and porcelain
- browning dish (Do not exceed recommended preheating time. Follow manufacturer's directions.)

#### These items can be used for short time reheating of foods that have little fat or sugar in them:

- wood, straw, wicker.

#### DO NOT USE

- metal pans and bakeware
- dishes with metallic trim
- non-heat-resistant glass
- non-microwave-safe plastics (margarine tubs)
- recycled paper products
- brown paper bags
- food storage bags
- metal twist-ties

Should you wish to check if a dish is safe for microwaving, place the empty dish in the oven and microwave on HIGH for 30 seconds. A dish which becomes very hot should not be used.

### ABOUT CHILDREN AND THE MICROWAVE

Children below the age of 7 should use the microwave oven with a supervising person very near to them. Between the ages of 7 and 12, the supervising person should be in the same room.

The child must be able to reach the oven comfortably; if not, he/she should stand on a sturdy stool.

At no time should anyone be allowed to lean or swing on the oven door.

#### The following coverings are ideal:

- Paper towels are good for covering foods for reheating and absorbing fat while cooking bacon.
- Wax paper can be used for cooking and reheating.
- Plastic wrap that is specially marked for microwave use can be used for cooking and reheating. DO NOT allow plastic wrap to touch food. Vent so steam can escape.
- Lids that are microwave-safe are a good choice because heat is kept near the food to hasten cooking.
- Oven cooking bags are good for large meats or foods that need tenderizing. DO NOT use metal twist ties. Remember to slit bag so steam can escape.

#### How to use aluminum foil in your microwave oven:

- Small flat pieces of aluminum foil placed smoothly on the food can be used to shield areas that are either defrosting or cooking too quickly.
- Foil should not come closer than one inch to any surface of the oven.

Should you have questions about utensils or coverings, check a good microwave cookbook or follow recipe suggestions.

### ACCESSORIES

There are many microwave accessories available for purchase. Evaluate carefully before you purchase so that they meet your needs. A microwave-safe thermometer will assist you in determining correct doneness and assure you that foods have been cooked to safe temperatures. Fisher & Paykel is not responsible for any damage to the oven when accessories are used.

Children should be taught all safety precautions: use potholders, remove coverings carefully, pay special attention to packages that crisp food because they may be extra hot.

Don't assume that because a child has mastered one cooking skill he/she can cook everything.

Children need to learn that the microwave oven is not a toy. See page 25 for Child Lock feature.



# INFORMATION YOU NEED TO KNOW

---

## ABOUT MICROWAVE COOKING

- Arrange food carefully. Place thickest areas towards outside of dish.
- Watch cooking time. Cook for the shortest amount of time indicated and add more as needed. Food severely overcooked can smoke or ignite.
- Cover foods while cooking. Check recipe or cookbook for suggestions: paper towels, wax paper, microwave plastic wrap or a lid. Covers prevent spattering and help foods to cook evenly.
- Shield with small flat pieces of aluminum foil any thin areas of meat or poultry to prevent overcooking before dense, thick areas are cooked thoroughly.
- Stir foods from outside to center of dish once or twice during cooking, if possible.
- Turn foods over once during microwaving to speed cooking of such foods as chicken and hamburgers. Large items like roasts must be turned over at least once.
- Rearrange foods such as meatballs halfway through cooking both from top to bottom and from the center of the dish to the outside.
- Add standing time. Remove food from oven and stir, if possible. Cover for standing time which allows the food to finish cooking without overcooking.
- Check for doneness. Look for signs indicating that cooking temperatures have been reached.

### Doneness signs include:

- Food steams throughout, not just at edge.
- Center bottom of dish is very hot to the touch.
- POULTRY thigh joints move easily.
- Meat and poultry show no pinkness.
- Fish is opaque and flakes easily with a fork.

## ABOUT SAFETY

- Check foods to see that they are cooked to the United States Department of Agriculture's recommended temperatures.

TEMP	FOOD
160°F	... for fresh pork, ground meat, boneless white poultry, fish, seafood, egg dishes and frozen prepared food.
165°F	... for leftover, ready-to-SENSOR REHEAT refrigerated, and deli and carry-out 'fresh' food.
170°F	... white meat of poultry.
180°F	... dark meat of poultry.

To test for doneness, insert a meat thermometer in a thick or dense area away from fat or bone. NEVER leave the thermometer in the food during cooking, unless it is approved for microwave oven use.

- ALWAYS use potholders to prevent burns when handling utensils that are in contact with hot food. Enough heat from the food can transfer through utensils to cause skin burns.
- Avoid steam burns by directing steam away from the face and hands. Slowly lift the farthest edge of a dish's covering and carefully open popcorn and oven cooking bags away from the face.
- Stay near the oven while it's in use and check cooking progress frequently so that there is no chance of overcooking food.
- NEVER use the cavity for storing cookbooks or other items.
- Select, store and handle food carefully to preserve its high quality and minimize the spread of foodborne bacteria.
- Keep waveguide cover clean. Food residue can cause arcing and/or fires.
- Use care when removing items from the oven so that the utensil, your clothes or accessories do not touch the safety door latches.

# PART NAMES

## MICROWAVE OVEN PARTS

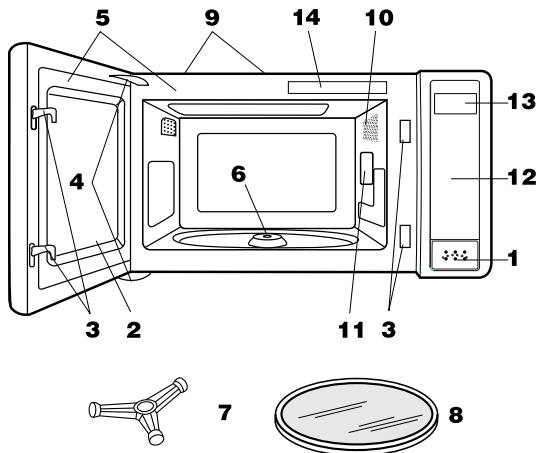

- 1 One touch door open button  
Push to open door.
- 2 Oven door with see-through window
- 3 Safety door latches  
The oven will not operate unless the door is securely closed.
- 4 Door hinges
- 5 Door seals and sealing surfaces
- 6 Turntable motor shaft
- 7 Removable turntable support  
Carefully place the turntable support in the center of the oven floor.
- 8 Removable turntable  
Place the turntable on the turntable support securely. The turntable will rotate clockwise or counterclockwise. Only remove for cleaning.
- 9 Ventilation openings (Rear)
- 10 Oven light  
It will light when oven is operating or door is open.
- 11 Waveguide cover: DO NOT REMOVE.
- 12 Auto-Touch control panel
- 13 Interactive display: 99 minutes, 99 seconds
- 14 Menu label

## CONTROL PANEL

The two-line, Interactive Display spells out operating steps and shows cooking hints. When HELP is lighted in the display, touch the **HELP MENU** pad to read a specific hint which may assist you.

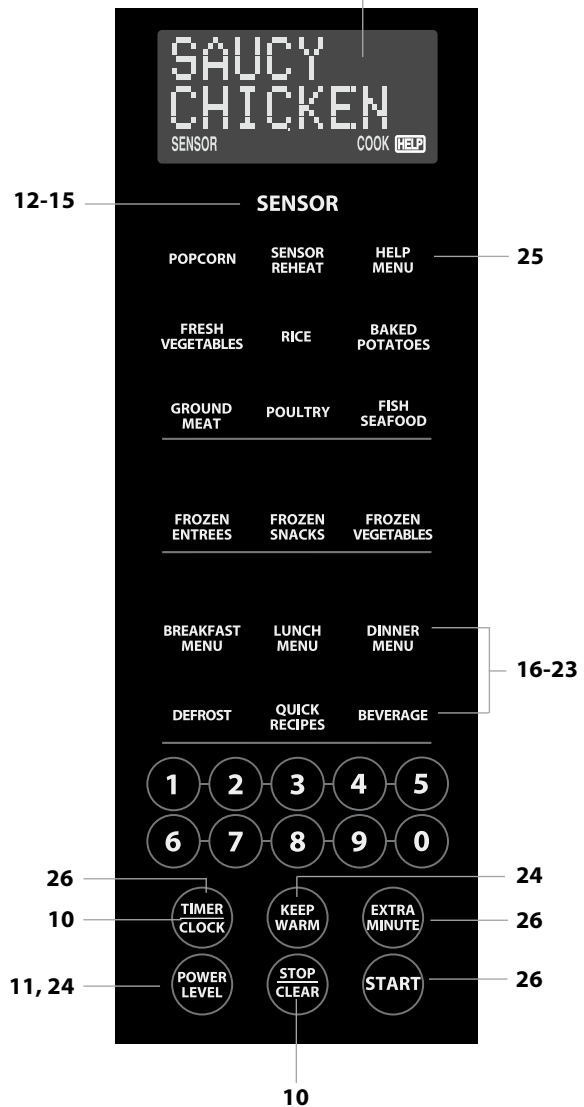

Number next to the control panel illustration indicates pages on which there are feature descriptions and usage information.











## BEFORE OPERATING

---

- Before operating your new microwave oven make sure you read and understand this operation manual completely.
- Before the oven can be used, follow these procedures:
  1. Plug in the oven. Close the door. The oven display will show *WELCOME PRESS CLEAR AND PRESS CLOCK*.
  2. Touch the **STOP/CLEAR** pad.  will appear.
  3. Set clock.

### TO SET THE CLOCK

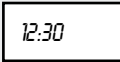
- Suppose you want to enter the correct time of day 12:30 (AM or PM).

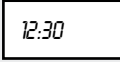
PROCEDURE	DISPLAY
<b>1</b>   Touch <b>TIMER/CLOCK</b> pad and number 2 pad.	 
<b>2</b>     Enter the correct time of day by touching the numbers in sequence.	
<b>3</b>  Touch <b>TIMER/CLOCK</b> pad again.	

This is a 12 hour clock. If you attempt to enter an incorrect clock time,  will appear in the display. Touch the **STOP/CLEAR** pad and re-enter the time.

- If the electrical power supply to your microwave oven should be interrupted, the display will inter-mittently show *WELCOME PRESS CLEAR AND PRESS CLOCK* after the power is reinstated. If this occurs during cooking, the program will be erased. The time of day will also be erased. Simply touch **STOP/CLEAR** pad and reset the clock for the correct time of day.

### STOP/CLEAR

Touch the **STOP/CLEAR** pad to:

1. Erase if you make a mistake during programming.
2. Cancel timer.
3. Stop the oven temporarily during cooking.
4. Return the time of day to the display.
5. Cancel a program during cooking, touch twice.

# MANUAL OPERATION

## TIME COOKING

Your oven can be programmed for 99 minutes and 99 seconds (99.99). Always enter the seconds after the minutes, even if they are both zeros.

- Suppose you want to cook for 5 minutes at 100%.

PROCEDURE		DISPLAY
<b>1</b>	<input type="text" value="5"/> <input type="text" value="0"/> <input type="text" value="0"/> Enter cooking time.	
<b>2</b>	<input type="button" value="START"/> Touch <b>START</b> pad.	

## MANUAL DEFROST

If the food that you wish to defrost is not listed on the DEFROST CHART or is above or below the limits in the 'Amount' column on the DEFROST CHARTS (page 21 and 22), you need to defrost manually.

You can defrost any frozen food, either raw or previously cooked, by using POWER LEVEL 3. Follow the exact 3-step procedure found under To Set POWER LEVEL. Estimate defrosting time and press **POWER LEVEL** eight times for 30% power.

For either raw or previously cooked frozen food the rule of thumb is approximately 4 minutes per pound. For example, defrost 4 minutes for 1 pound of frozen spaghetti sauce.

Always stop the oven periodically to remove or separate the portions that are defrosted. If food is not defrosted at the end of the estimated defrosting time, program the oven in 1 minute increments at 30% until totally defrosted.

When using plastic containers from the freezer, defrost only long enough to remove from the plastic in order to place in a microwave-safe dish.

## TO SET POWER LEVEL

There are eleven preset power levels.

Using lower power levels increases the cooking time which is recommended for foods such as cheese, milk and long slow cooking of meats. Consult cookbook or recipes for specific recommendations.

TOUCH POWER LEVEL PAD NUMBER OF TIMES FOR DESIRED POWER	APPROXIMATE PERCENTAGE OF POWER	COMMON WORDS FOR POWER LEVELS
POWER LEVEL x 1	100%	High
POWER LEVEL x 2	90%	
POWER LEVEL x 3	80%	
POWER LEVEL x 4	70%	Medium High
POWER LEVEL x 5	60%	
POWER LEVEL x 6	50%	Medium
POWER LEVEL x 7	40%	
POWER LEVEL x 8	30%	Med Low/Defrost
POWER LEVEL x 9	20%	
POWER LEVEL x 10	10%	Low
POWER LEVEL x 11	0%	

- Suppose you want to defrost for 5 minutes at 30%.

PROCEDURE		DISPLAY
<b>1</b>	<input type="text" value="5"/> <input type="text" value="0"/> <input type="text" value="0"/> Enter defrosting time.	
<b>2</b>	<input type="button" value="POWER LEVEL"/> x 8 Touch <b>POWER LEVEL</b> pad eight times or hold down until the desired power appears.	
<b>3</b>	<input type="button" value="START"/> Touch <b>START</b> pad.	

When the defrost time is complete, a long tone will sound and  will appear in the display.

# SENSOR

The sensor is a semi-conductor device that detects the vapor (moisture and humidity) emitted from the food as it heats. The sensor adjusts the cooking times and power level for various foods and quantities.

## Using Sensor Settings:

1. After oven is plugged in, wait 2 minutes before using SENSOR.
2. Be sure the exterior of the cooking container and the interior of the oven are dry. Wipe off any moisture with a dry cloth or paper towel.
3. The oven works with foods at normal storage temperature. For example, popcorn would be at room temperature.
4. Any SENSOR selection can be programmed with More or Less Time Adjustment. See page 24.
5. More or less food than the quantity listed in the chart should be cooked following the guidelines in any microwave cookbook.
6. During the first part of SENSOR, the food name will appear on the display. Do not open the oven door or touch **STOP/CLEAR** during this part of the cooking cycle. The measurement of vapor will be interrupted. If this occurs, an error message will appear. To continue cooking, touch the **STOP/CLEAR** pad and cook manually.

When the sensor detects the vapor emitted from the food, remainder of cooking time will appear. The door may be opened when remaining cooking time appears on the display. At this time, you may stir or season food, as desired.

7. If the sensor does not detect vapor properly when popping popcorn, the oven will turn off, and the correct time of day will be displayed. If the sensor does not detect vapor properly when cooking other foods, **ERROR** will be displayed, and the oven will turn off.
8. Check food for temperature after cooking. If additional time is needed, continue to cook manually.
9. Each food has a cooking hint. Touch **HELP MENU** pad when the HELP indicator is lighted in the display.

## Covering Foods:

Some foods work best when covered. Use the cover recommended in the SENSOR chart for these foods.

1. Casserole lid.
2. Plastic wrap: Use plastic wrap recommended for microwave cooking. Cover dish loosely; allow approximately 1/2 inch to remain uncovered to allow steam to escape. Plastic wrap should not touch food.
3. Wax paper: Cover dish completely; fold excess wrap under dish to secure. If dish is wider than paper, overlap two pieces at least one inch to cover.

Be careful when removing any covering to allow steam to escape away from you.

## EXAMPLE:

You can cook many foods by simply selecting the food and touching **START**. You don't need to calculate cooking time or power level.

- Suppose you want to SENSOR REHEAT canned chili.

## PROCEDURE

- 1 Touch **SENSOR REHEAT** pad.



- 2 Touch **START** pad.



When the sensor detects the vapor emitted from the food, the remainder of cooking time will appear.

## NOTE:

The FRESH VEGETABLES and POULTRY settings have 2 choices. Follow directions in the Interactive Display to choose desired option.

# SENSOR

## SENSOR CHART

POPCORN	1 package	Use only popcorn packaged for microwave oven use. Try several brands to decide which you like the best. Do not try to pop unpopped kernels.															
	1.5 - 3.5 oz bag	Touch <b>POPCORN</b> pad and then <b>START</b> .															
SENSOR REHEAT	4 - 36 oz	Place in dish or casserole slightly larger than amount to be reheated. Flatten, if possible. Cover with lid, plastic wrap or wax paper. Use covers such as plastic wrap or lids with larger quantities of more dense foods such as stews. After reheating, stir well, if possible. Foods should be very hot. If not, continue to heat with variable power and time. After stirring, re-cover and allow to stand 2 to 3 minutes.															
FRESH VEGETABLES Soft:		Wash and place in casserole. Add no water if vegetables have just been washed. Cover with lid for tender vegetables. Use plastic wrap for tender-crisp vegetables. Touch <b>FRESH VEGETABLES</b> , number ① and <b>START</b> pads. After cooking, stir, if possible. Let stand, covered, for 2 to 5 minutes.															
Broccoli	.25 - 2.0 lb																
Brussels sprouts	.25 - 2.0 lb																
Cabbage	.25 - 2.0 lb																
Cauliflower (flowerets)	.25 - 2.0 lb																
Cauliflower (whole)	1 med.																
Spinach	.25 - 1.0 lb																
Zucchini	.25 - 2.0 lb																
Baked apples	2 - 4 med.																
FRESH VEGETABLES Hard:		Place in casserole. Add 1-4 tbsp water. Cover with lid for tender vegetables. Use plastic wrap cover for tender-crisp vegetables. Touch <b>FRESH VEGETABLES</b> , number ② and <b>START</b> pads. After cooking, stir, if possible. Let stand, covered, for 2 to 5 minutes.															
Carrots, sliced	.25 - 1.5 lb																
Corn on the cob	2 - 4																
Green beans	.25 - 1.5 lb																
Winter squash:																	
diced	.25 - 1.5 lb																
halves	1 - 2																
RICE	.5 - 2.0 cups	Place rice into a deep casserole dish and add double quantity of water. Cover with lid or plastic wrap. After cooking, stir, cover and let stand 3 to 5 minutes or until all liquid has been absorbed.															
		<table border="1" style="width: 100%; border-collapse: collapse;"> <thead> <tr> <th style="text-align: center;">Rice</th> <th style="text-align: center;">Water</th> <th style="text-align: center;">Size of casserole dish</th> </tr> </thead> <tbody> <tr> <td style="text-align: center;">.5 cup</td> <td style="text-align: center;">1 cup</td> <td style="text-align: center;">1.5 quart</td> </tr> <tr> <td style="text-align: center;">1 cup</td> <td style="text-align: center;">2 cups</td> <td style="text-align: center;">2 quart</td> </tr> <tr> <td style="text-align: center;">1.5 cups</td> <td style="text-align: center;">3 cups</td> <td style="text-align: center;">2.5 or 3 quart</td> </tr> <tr> <td style="text-align: center;">2 cups</td> <td style="text-align: center;">4 cups</td> <td style="text-align: center;">3 quart or larger</td> </tr> </tbody> </table>	Rice	Water	Size of casserole dish	.5 cup	1 cup	1.5 quart	1 cup	2 cups	2 quart	1.5 cups	3 cups	2.5 or 3 quart	2 cups	4 cups	3 quart or larger
Rice	Water	Size of casserole dish															
.5 cup	1 cup	1.5 quart															
1 cup	2 cups	2 quart															
1.5 cups	3 cups	2.5 or 3 quart															
2 cups	4 cups	3 quart or larger															
BAKED POTATOES	1 - 8 med.	Pierce. Place on paper-towel-lined turntable. After cooking, remove from oven, wrap in aluminum foil and let stand 5 to 10 minutes.															
GROUND MEAT	.25 - 2.0 lb	Use this setting to cook ground beef or turkey as patties or in a casserole to be added to other ingredients. Place patties on a microwave-safe rack and cover with wax paper. Place ground meat in a casserole and cover with wax paper or plastic wrap. When oven stops, turn patties over or stir meat in casserole to break up large pieces. Re-cover and touch <b>START</b> . After cooking, let stand, covered, for 2 to 3 minutes.															

# SENSOR

## SENSOR CHART (CONTINUED)

FOOD	AMOUNT	PROCEDURE
POULTRY: Boneless	.5 - 2.0 lb	Use boneless breast of chicken or turkey. Cover with vented plastic wrap. Touch <b>POULTRY</b> , number ① and <b>START</b> pads. When oven stops, rearrange. Re-cover and touch <b>START</b> pad. After cooking, let stand, covered, 3 to 5 minutes. Poultry should be 160°F.
Bone-in	.5 - 3.0 lb	Arrange pieces with meatiest portions toward outside of glass dish or microwave safe rack. Cover with vented plastic wrap. Touch <b>POULTRY</b> , number ② and <b>START</b> pads. After cooking, let stand, covered, 3 to 5 minutes. Dark meat should be 180°F and white meat should be 170°F.
FISH/SEAFOOD	.25 - 2.0 lb	Arrange in ring around shallow glass dish (roll fillet with edges underneath). Cover with vented plastic wrap. After cooking, let stand, covered for 3 minutes.
FROZEN ENTREES	6 - 17 oz	Use this pad for frozen convenience foods. It will give satisfactory results for most brands. You may wish to try several and choose your favorite. Remove package from outer wrapping and follow package directions for covering. After cooking, let stand, covered, for 1 to 3 minutes.
FROZEN SNACKS	3 - 8 oz	Use for frozen French fries, cheese sticks, appetizers etc. Remove from outer package. Follow package directions for how to wrap or cover. Be careful when removing from the oven as snack may be very hot.
FROZEN VEGETABLES	.25 - 1.5 lb	Add no water. Cover with lid or plastic wrap. After cooking, stir and let stand, covered, for 3 minutes.

## SENSOR RECIPES

### Cranberry Fluff

Makes 6 to 8 servings

- |   |   |
|---|---|
| 2 cups fresh cranberries                    | 1/2 pint whipping cream, whipped or           |
| 1 cup water                                 | 1 carton (8 ounces) non-dairy whipped topping |
| 3/4 cup sugar                               |   |
| 1 carton (3 ounces) orange flavored gelatin |   |

- Combine cranberries, water and sugar in a 2-quart casserole. Cover with wax paper. Microwave using **SENSOR REHEAT** Less. Drain cranberries and reserve liquid.
- Add enough hot water to reserved liquid to make 2 cups. Stir the gelatin into hot liquid until it dissolves. Cover with wax paper. Microwave using **SENSOR REHEAT** Less.
- Add berries and cool. Refrigerate until it starts to have a soft gel, like jelly. Fold whipped cream into cooled cranberry mixture. Spoon into serving dishes and garnish with extra whipped cream. Refrigerate until ready to serve.

# SENSOR

## SENSOR RECIPES (CONTINUED)

### Shrimp Pasta Sauce

Makes 4 servings

- |  |   |
|--|---|
| 1 pound of shrimp, peeled and deveined   | 1 cup thinly sliced scallions (about 2 bunches) |
| 2 cups canned tomato puree               | 1 clove of garlic, minced                       |
| 1 tablespoon tomato paste                | salt and pepper to taste                        |
| 1/2 cup thinly sliced fresh basil leaves | Parmesan cheese                                 |
| 1/2 teaspoon oregano                     |   |

- 1 Place shrimp in 2-quart, covered casserole.
- 2 Microwave using **FISH/SEAFOOD**. Drain and set aside.
- 3 Combine tomato puree, tomato paste, basil, oregano, scallions, garlic, salt and pepper in 2-quart casserole.
- 4 Microwave using **SENSOR REHEAT**.
- 5 Combine sauce with cooked shrimp.
- 6 Serve sauce over cooked pasta. Garnish with Parmesan cheese.

### Glazed Apple Slices

Makes 6 to 8 servings

- |                                   |  |
|-----------------------------------|--|
| 1/4 cup brown sugar               | 3/4 cup orange juice   |
| 3 tablespoons margarine or butter | 1 tablespoon cornstarch  |
| 2 tablespoons apricot preserves   | 4 baking apples (about 1 1/2 pounds), peeled and sliced into 8 pieces each |
| 1/2 teaspoon ground nutmeg        | 3 tablespoon chopped green pistachios                                      |
| 1/4 teaspoon salt                 |  |
| 1/2 cup sugar                     |  |

- 1 Combine brown sugar, margarine and apricot preserves in a small bowl. Microwave at HIGH (100%) until margarine melts and preserves soften, 45 seconds to 1 minute. Stir in nutmeg, salt, sugar, orange juice and cornstarch. Microwave at HIGH (100%) until thickened, 4 to 6 minutes, stirring several times.
- 2 Arrange apple slices in a large microwave serving dish. Spread hot sauce over apples. Cover well with vented plastic wrap. Microwave using **FRESH VEGETABLES: Soft**. Allow to cool 5 minutes before serving.
- 3 Sprinkle with pistachios. Serve alone or over vanilla ice cream or sponge cake.

### Herb-and-Cheese Chicken Breasts

Makes 8 servings

- |  |  |
|--|--|
| 1 8-ounce package cream cheese, softened | 1 garlic clove, minced                     |
| 2 tablespoons milk                       | 4 whole chicken breasts with skin and bone |
| 2 green onions, minced                   | 1/2 cup dried bread crumbs                 |
| 1 tablespoon minced parsley              | 1 teaspoon paprika                         |
| 1/2 teaspoon thyme leaves                | 3 tablespoons butter or margarine, melted  |

- 1 In a small bowl, combine cream cheese, milk, green onions, parsley, thyme, and garlic.
- 2 Push fingers between skin and meat of each chicken breast to form a pocket. Spread an equal amount of cream cheese mixture in each pocket.
- 3 On waxed paper, combine bread crumbs and paprika. Dip chicken breasts into melted butter, then roll in seasoned bread crumbs to coat.
- 4 In 8-inch x 8-inch baking dish, place chicken and cover with plastic wrap. Microwave using **POULTRY (bone-in)**.
- 5 Serve chicken with rice.



## OTHER COOKING FEATURES

Your oven has 6 convenience pads to assist with meal preparation. There are some foods in the BREAKFAST MENU, LUNCH MENU, DINNER MENU and QUICK RECIPES that use the sensor. See the sensor cooking information on page 12. For foods not using the sensor, follow the directions in the Interactive Display to enter quantity.

### BREAKFAST MENU AND LUNCH MENU

BREAKFAST MENU and LUNCH MENU are for cooking and heating popular foods that take a short amount of time.

- Suppose you want to use BREAKFAST MENU to cook 2 servings of hot cereal.

PROCEDURE	DISPLAY
<p><b>1</b> <span style="border: 1px solid black; padding: 2px;">BREAKFAST MENU</span></p> <p>Touch <b>BREAKFAST MENU</b> pad.</p>	<div style="border: 1px solid black; padding: 5px; text-align: center;">SEE LABEL</div> <div style="display: flex; justify-content: space-around; margin-top: 10px;"> <div style="border: 1px solid black; padding: 5px; text-align: center;">SELECT FOOD</div> <div style="border: 1px solid black; padding: 5px; text-align: center;">NUMBER</div> </div>
<p><b>2</b> <span style="border: 1px solid black; padding: 2px;">3</span></p> <p>Select desired <b>BREAKFAST MENU</b> setting by touching number pad. (Ex: Touch number ③ pad to select hot cereal)</p> <p><span style="border: 1px solid black; padding: 2px;">2</span></p> <p>Enter quantity. (Ex: Touch number ② pad for servings)</p>	<div style="border: 1px solid black; padding: 5px; text-align: center;">HOT CEREAL</div> <div style="display: flex; justify-content: space-around; margin-top: 10px;"> <div style="border: 1px solid black; padding: 5px; text-align: center;">ENTER NUMBER</div> <div style="border: 1px solid black; padding: 5px; text-align: center;">OF SERVINGS</div> </div> <div style="display: flex; justify-content: space-around; margin-top: 10px;"> <div style="border: 1px solid black; padding: 5px; text-align: center;">2 SERVINGS</div> <div style="border: 1px solid black; padding: 5px; text-align: center;">PRESS START</div> </div>
<p><b>3</b> <span style="border: 1px solid black; padding: 2px;">START</span></p> <p>Touch <b>START</b> pad.</p>	
<p>After cooking, follow the directions in the display.</p>	

**NOTE:**

1. Heat rolls/muffins setting has 2 choices. Follow directions in the Interactive Display to choose desired option.
2. BREAKFAST MENU can be programmed with More or Less Time Adjustment. Touch the **POWER LEVEL** pad once or twice before touching **START** pad. See page 24.
3. Each food has a cooking hint. Touch **HELP MENU** pad when the HELP indicator is lighted in the display.
4. Should you attempt to enter more or less than the allowed amount, an error message will appear in the display.  
  
More or less than the quantity listed in the chart should be cooked following the guidelines in any microwave book.
5. The final cooking result will vary according to the food condition (eg initial temperature, shape, quality, covering). Check food for temperature after cooking. If additional time is needed, continue to cook manually.

### BREAKFAST MENU CHART

1. SCRAMBLED EGGS	1 - 9 eggs	For each egg, use 1 teaspoon of butter or margarine and 1 tablespoon of milk. Place butter or margarine in dish, measuring cup or casserole large enough for the egg to expand. Mix egg and milk together. Pour onto butter or margarine in dish. Place in oven and program. When audible signals are heard, stir egg mixture moving the cooked portion to the center of the dish and uncooked portion to the outside. After cooking, stir and let stand, covered, until set. Note that eggs will be slightly undercooked when removed from the oven.
2. BACON	2 - 6 slices	Place bacon on paper plate, lined with paper towel. Bacon should not extend over the rim of plate. Cover with another paper towel. Allow bacon to stand a few minutes after removing from the oven to complete the cooking.

## OTHER COOKING FEATURES

### BREAKFAST MENU CHART (CONTINUED)

\*IT IS NOT NECESSARY TO ENTER AMOUNT

FOOD	AMOUNT	PROCEDURE
3. HOT CEREAL	1 - 6 servings	Use individual packets or bulk cereal in your favorite variety: oatmeal, oat bran, cream of wheat, farina or wheatena. Follow package directions for the correct amount of water or milk. To prevent boil overs, it is very important to choose a large container because microwave cooking of cereal causes high boiling. If the oven stops, stir and touch <b>START</b> . After cooking, stir and let stand, covered, for 2 minutes.
4. HEAT ROLLS/ MUFFINS:		Use this pad to warm rolls, muffins, biscuits, bagels etc. Large items should be considered as 2 or 3 regular size. Arrange on plate: cover with paper towel.
Fresh	1 - 10 pieces	To warm fresh rolls and muffins, touch <b>BREAKFAST MENU</b> , number ④ pad, and touch number ① pad. Then enter desired quantity and touch <b>START</b> pad. For refrigerated rolls or muffins, it may be necessary to double the entered amount to ensure the proper serving temperature. For example, enter quantity of 2 for 1 refrigerated muffin.
Frozen	1 - 10 pieces	For frozen rolls and muffins, touch <b>BREAKFAST MENU</b> pad and touch number ④ pad, then number ② pad. Then enter desired quantity and touch <b>START</b> pad.
5. FROZEN BREAKFAST FOODS*	1 (3 - 6 oz)	This setting works well for frozen breakfast entrees, pancakes, waffles, burritos etc. Follow manufacturer's directions for how to prepare for microwaving. Allow to stand 1 or 2 minutes after cooking.

### LUNCH MENU CHART

\*IT IS NOT NECESSARY TO ENTER AMOUNT

1. MEAL IN A CUP*	1 cup	This setting is ideal for individual portions of canned food packed in a small microwaveable container, usually 6 to 8 ounces. Remove inner metal lid and replace outer microwaveable lid. After cooking, stir food and allow to stand 1 or 2 minutes.
2. HOT DOGS IN BUNS*	1 - 4 pieces	Place hot dog in bun. Wrap each with paper towel or napkin.
3. SOUP*	1 - 8 cups	Place in bowl or casserole. Cover with lid or plastic wrap. At end, stir, re-cover and let stand 1 to 3 minutes.
4. MICROWAVE PIZZA*	1 (6 - 8 oz)	Use for frozen microwave pizza. Remove from package and unwrap. Follow package directions for use of package and/or silver crisping disk.
5. FROZEN SANDWICH*	1 (3 - 6 oz)	Use for frozen microwaveable sandwiches. Remove from package and follow directions for placing in the oven.

## OTHER COOKING FEATURES

### DINNER MENU AND QUICK RECIPES

DINNER MENU and QUICK RECIPES each offer five simple-to-prepare but great tasting meals. Follow the specific directions on the Recipe Card and in the Interactive Display.

- Suppose you want to use DINNER MENU to cook Saucy Chicken.

<p><b>1</b></p> <p><b>DINNER MENU</b></p> <p>Touch <b>DINNER MENU</b> pad.</p>	<p>SEE LABEL</p> <p>SELECT FOOD</p> <p>NUMBER</p>
<p><b>2</b></p> <p><b>1</b></p> <p>Select desired <b>DINNER MENU</b> setting by touching number pad. (Ex: Touch number ① pad to select Saucy Chicken)</p> <p>Follow the Recipe Card for ingredients and instructions.</p>	<p>SAUCY CHICKEN</p> <p>SEE RECIPE</p> <p>CARD</p> <p>PRESS START</p>

PROCEDURE	DISPLAY
<p><b>3</b></p> <p><b>START</b></p> <p>Touch <b>START</b> pad.</p>	
<p><b>4</b></p> <p>When the oven stops, the display will show the instruction number on the Recipe Card.</p> <p>Follow the instructions on the Recipe Card.</p> <p><b>START</b></p> <p>Touch <b>START</b> pad.</p>	<p>CHECK RECIPE</p> <p>INSTRUCTIONS 2</p> <p>PRESS START</p>
<p><b>5</b></p> <p>At end, the display will show the instruction number on the Recipe Card.</p> <p>Follow the instructions on the Recipe Card.</p>	<p>CHECK RECIPE</p> <p>INSTRUCTIONS 3</p>

### DINNER MENU RECIPES (RECIPES SERVE 6)

#### 1. SAUCY CHICKEN

1. Place in a 3 quart casserole:

- 1 tablespoon oil
- 1/2 pound mushrooms, sliced
- 1 onion, chopped
- 1 tablespoon minced garlic

Stir well and cover. Touch **DINNER MENU**, number ① to select SAUCY CHICKEN and then touch **START**.

2. Blend together:

- 8 ounces reduced fat cream cheese, softened
- 1/4 cup milk

Stir into the cream cheese mixture:

- 1 10-ounce package of frozen peas
- 2 cups cooked thinly sliced chicken breast
- Salt and pepper to taste

At pause, drain liquid from mushrooms, etc.

Add cream cheese/peas/chicken mixture and stir together. Re-cover. Touch **START**.

3. At end, stir in 1 cup shredded Monterey Jack cheese.

*Serve on top of baked potatoes or cooked pasta.*

#### 2. HAWAIIAN PORK

1. Place in a 3 quart casserole:

- 1 tablespoon oil
- 1 pound boneless pork loin, cut into 1-inch strips, seasoned with salt and pepper

Stir well and cover. Touch **DINNER MENU**, number ② to select HAWAIIAN PORK and then touch **START**.

2. Combine well in a large bowl:

- 1 cup peach or apricot preserves
- 1/4 cup barbecue sauce
- 2 tablespoons soy sauce
- 2 tablespoons cornstarch
- 1 cup coarsely chopped onions

At pause, add preserves/barbecue mixture and stir together well.

Re-cover. Touch **START**.

3. At pause, add:

- 1 8-ounce can sliced water chestnuts, drained
- 1 green pepper, seeded and cut into 2-inch thin strips
- 1 red pepper, seeded and cut into 2-inch thin strips
- 1 20-ounce can pineapple chunks, drained

Stir to combine. Re-cover. Touch **START**.

4. At end, stir again.

*Serve on cooked rice.*

## OTHER COOKING FEATURES

---

### 3. FIESTA CHILI

---

1. Place in a 3 quart casserole:
  - 1 1/4 pounds ground turkey
  - 1/2 cup diced onions
  - 1/2 cup diced red pepper

Break up turkey and stir in onions and red pepper. Cover. Touch **DINNER MENU**, number ③ to select FIESTA CHILI and then touch **START**.

2. At pause, drain and add to the casserole:
  - 8 ounces chunky salsa

- 1 11-ounce can of Mexican corn, drained
- 1 15-ounce can chili with beans
- 1 to 3 teaspoons chili powder

Stir together well. Re-cover. Touch **START**.

3. At end, stir well.

*Serve over cooked rice or nacho chips.*

*Top with 2 cups shredded Monterey Jack or Cheddar cheese.*

### 4. GLAZED SALMON

---

1. Combine:
  - 1/4 cup orange juice concentrate
  - 2 tablespoons honey mustard
  - 1 tablespoon grated fresh ginger or 2 teaspoons ground ginger

Place in 7" x 11" glass casserole:

- 1 1/2 pounds salmon fillet

Drizzle 1/2 of the orange mixture over top of salmon.

Cover with plastic wrap. Touch **DINNER MENU**, number ④ to select GLAZED SALMON and then touch **START**.

2. At pause, place around edge of salmon:
  - 3 cups broccoli florets
  - 1 red pepper, cut into thin strips

Drizzle remaining orange mixture over vegetables.

Top all with 2 tablespoons toasted sesame seeds.

Touch **START**.

3. At end, allow to stand, covered, for 3 to 5 minutes.

*Serve with buttered rice, pasta or potatoes garnished with parsley.*

### 5. HEALTHY FRITTATA

---

1. Grease 9" pie plate. Place in it:
  - 1/2 pound mushrooms, sliced
  - 3/4 cup chopped onion
  - 1 tablespoon minced garlic
  - 1/4 pound chopped low-fat smoked sausageCover with plastic wrap. Touch **DINNER MENU**, number ⑤ to select HEALTHY FRITTATA and then touch **START**.

2. At pause, drain and set aside. In a medium bowl, combine and stir together well:

- 3 large eggs
- 1/2 cup nonfat sour cream
- 1 tablespoon Dijon mustard

- 1/2 teaspoon salt
- 1/8 teaspoon pepper

Add and stir together:

- 1/2 10-ounce package frozen chopped spinach, thawed and squeezed dry
- 1 cup shredded Swiss cheese

Pour mixture in bowl over top of mushroom/onion/sausage mixture. Mix together carefully.

Do not cover. Touch **START**.

3. At end, remove from oven and allow to stand for 3 to 5 minutes.

*Serve with tossed salad and sliced tomatoes for brunch.*

## QUICK RECIPES (RECIPES SERVE 6)

### 1. BEEF WRAPS

---

1. Place in a 2-quart casserole:
  - 1 pound ground beefBreak apart and cover. Touch **QUICK RECIPES**, number ① to select BEEF WRAPS and then touch **START**.

2. At pause, drain fat and break ground beef into small pieces. Add to casserole:

- 1 10-ounce package frozen chopped spinach, thawed and drained

- 1 1/2 cups salsa
- 1-3 teaspoons chili powder

Stir together well. Re-cover. Touch **START**.

3. At end, stir well and place in 8 warmed corn tortillas. Top with 1 cup shredded Cheddar cheese.

## OTHER COOKING FEATURES

---

### QUICK RECIPES (RECIPES SERVE 6) CONTINUED

#### 2. MEXICAN CHICKEN

---

1. Place in layers in a 3-quart casserole:
  - 2 cups instant rice
  - 1 cup prepared fajita sauce mixed with 1/2 cup chicken broth or bouillon
  - 2 10-ounce packages frozen seasoning mix (onion, peppers, parsley and celery)
  - 1 pound boneless chicken breast, cut into 1-inch thin strips

Cover. Touch **QUICK RECIPES**, number ② to select MEXICAN CHICKEN and then touch **START**.

2. At pause, stir together being sure that chicken strips are separated and mixed into the rice/sauce. Re-cover. Touch **START**.

3. At end, stir.

*Serve with buttered green beans and toasted tortillas.*

#### 3. ITALIAN SALAD

---

1. To cook pasta:  
Place in 3-quart casserole:
  - 6 cups very hot tap waterCover. Touch **QUICK RECIPES**, number ③ to select ITALIAN SALAD and then touch **START**.

2. At pause, add:
  - 8 ounces tricolored rotini or fusilli pastaDo not cover. Touch **START**.

3. At end, drain pasta and set aside.

To cook chicken:

Place in greased 9" pie plate:

- 1 pound boneless chicken breast, cut into 1-inch thin strips

Cover. Touch **START**.

4. At pause, rearrange, moving less done pieces to the outside of the pie plate.

Re-cover. Touch **START**.

5. Drain and set aside.

To make salad: Place in large salad bowl:

- Cooked rotini or fusilli
- Cooked chicken breast
- 2 tomatoes, cut into eighths
- 1/2 cup sliced black olives
- 1 cup mozzarella cheese, shredded
- 1/4 cup red onion, chopped
- 3/4-1 cup oil-vinegar type dressing with pesto

Toss together to coat all pieces.

*Serve immediately or chill to serve later.*

*Ideal when served with warm crusty rolls.*

#### 4. TUNA MACARONI

---

1. To cook macaroni:  
Place in 3-quart casserole:
  - 6 cups very hot tap waterCover. Touch **QUICK RECIPES**, number ④ to select TUNA MACARONI and then touch **START**.

2. At pause, add:
  - 2 cups elbow macaroni
  - 1 teaspoon salad oilDo not cover. Touch **START**.

3. At end, drain macaroni and set aside in the casserole.

Combine in bowl:

- 1 can cream of celery soup
- 1/2 cup milk

- 1/2 cup nonfat sour cream

Cover. Touch **START**.

Add to macaroni in casserole:

- Soup/milk/sour cream mixture
- 1 6 1/2-ounce can solid white water packed tuna fish, drained and flaked
- 1 cup frozen peas
- 1 cup shredded Cheddar cheese
- Salt and pepper to taste

Stir together until well mixed. Cover. Touch **START**.

4. At end, stir again.

*Serve with fresh carrot sticks, tossed salad and dinner rolls.*

#### 5. GARDEN MEDLEY

---

1. Place in a 2 1/2-quart casserole:
  - 1 pound peeled baking potatoes, cut into eighths and thinly sliced
  - 1 14 1/2-ounce can diced tomatoes
  - 2 teaspoons minced garlic
  - 1 teaspoon thyme leaves

Cover with a lid. Touch **QUICK RECIPES**, number ⑤ to select GARDEN MEDLEY and then touch **START**.

2. At pause, stir well and add:

- 1 16-ounce package frozen stir fry mixed vegetables
- 2 cups thinly sliced summer squash

Re-cover. Touch **START**.

3. At end, sprinkle top with 4 ounces shredded Cheddar cheese.

*Serve with spinach salad and chilled melon.*

## OTHER COOKING FEATURES

### DEFROST

DEFROST automatically defrosts all the foods found in the SUPER DEFROST and DEFROST CHARTS. Numbers 1–3 are for SUPER DEFROST that defrosts specific foods and weights very rapidly. For these choices, it is not necessary to enter weight.

### SUPER DEFROST

SUPER DEFROST rapidly defrosts specific foods and weights found in the SUPER DEFROST CHART below.

- Suppose you want to defrost 1.0 pound boneless poultry.

<b>1</b>	<b>DEFROST</b>	<i>SEE LABEL</i>		<i>SELECT FOOD</i>	<i>NUMBER</i>
	Touch <b>DEFROST</b> pad once.				
<b>2</b>	<b>2</b>	<i>1.0 POUND</i>		<i>BONELESS CHICKEN</i>	<i>PRESS START</i>
	Touch the number ② to select Boneless Poultry.				
<b>3</b>	<b>START</b>	Touch <b>START</b> pad.			
	The oven will stop so the food can be checked. The display will show: Close the door.	<i>TURN OVER</i>		<i>SEPARATE INTO</i>	<i>PIECES</i>
	<b>START</b>	Touch <b>START</b> pad.			

PROCEDURE	DISPLAY		
<b>4</b> After defrost cycle ends, follow the directions.	<table border="1" style="width: 100%; border-collapse: collapse; text-align: center;"> <tr> <td style="padding: 5px;"><i>LET STAND</i></td> <td style="padding: 5px;"><i>3-5 MINUTES</i></td> </tr> </table>	<i>LET STAND</i>	<i>3-5 MINUTES</i>
<i>LET STAND</i>	<i>3-5 MINUTES</i>		

**NOTE:**

1. To defrost other foods above or below the weights allowed on the SUPER DEFROST and DEFROST CHARTS, use time and 30% power. See Manual Defrost on page 11.
2. Any setting in the DEFROST can be programmed with More or Less Time Adjustment. Touch the **POWER LEVEL** pad once or twice before touching **START** pad.
3. Touch **HELP MENU** pad when the HELP indicator is lighted in the display for a helpful hint.
4. If you attempt to enter more or less than the amount as indicated in the DEFROST chart, an error message will appear in the display.

### SUPER DEFROST CHART

**\*IT IS NOT NECESSARY TO ENTER AMOUNT**

1. GROUND MEAT*	1.0 lb	At pause, turn over, removed any thawed pieces and break remainder apart. At end, let stand, covered, for 3 to 5 minutes.
2. BONELESS POULTRY*	1.0 lb	At pause, turn over and separate into pieces. At end, let stand, covered, for 3 to 5 minutes.
3. BONE-IN CHICKEN PIECES*	2.0 lb	At pause, turn over and separate into pieces. At end, let stand, covered, for 3 to 5 minutes.

**NOTE:**

Super Defrost provides just enough defrosting that the foods can be used in recipes or for cooking. There will be some ice crystals remaining.

## OTHER COOKING FEATURES

### DEFROST (CONTINUED)

- Suppose you want to defrost a 2.0 pound steak, using Defrost.

**1** DEFROST SEE LABEL

Touch **DEFROST** pad once.

SELECT FOOD
NUMBER

**2** 5

Select desired **DEFROST** setting by touching the desired number pad.  
(Ex: Touch the number pad 5 to select steak.)

STEAKS CHOPS
OR FISH

ENTER WEIGHT
IN POUNDS

2
0

Enter weight.  
(Ex: Touch number pads 2 and 0 for 2.0 lb.)

2.0 POUNDS
PRESS START

**3** START Touch **START** pad.

The oven will stop so the food can be checked.  
The display will show:

TURN FOOD
OVER
COVER EDGES

PROCEDURE	DISPLAY
<b>4</b> After the 1st stage, open the door. Turn steak over and shield any warm portions. Close the door.	
<span style="border: 1px solid black; padding: 2px 10px;">START</span>	Touch <b>START</b> pad.
<b>5</b> After the 2nd stage, open the door. Shield any warm portions. Close the door.	
	<div style="display: flex; justify-content: space-around;"> <span style="border: 1px solid black; padding: 2px 10px;">CHECK FOOD</span> <span style="border: 1px solid black; padding: 2px 10px;">COVER EDGES</span> </div>
<span style="border: 1px solid black; padding: 2px 10px;">START</span>	Touch <b>START</b> pad.
<b>6</b> After defrost cycle ends, follow the directions.	
	<div style="display: flex; justify-content: space-around;"> <span style="border: 1px solid black; padding: 2px 10px;">LET STAND</span> <span style="border: 1px solid black; padding: 2px 10px;">COVERED</span> </div>

4. GROUND MEAT	.5 - 3.0 lb	Remove any thawed pieces after each stage. Let stand, covered, for 5 to 10 minutes.
5. STEAKS CHOPS OR FISH	.5 - 4.0 lb	After each stage, rearrange and if there are warm or thawed portions, shield with small flat pieces of aluminum foil. Remove any meat or fish that is almost defrosted. Let stand, covered, for 10 to 20 minutes.
6. CHICKEN PIECES	.5 - 3.0 lb	After each stage, rearrange pieces or remove portions should they become warm or thawed. Let stand, covered, for 10 to 20 minutes.
7. ROAST	2.0 - 4.0 lb	Start defrosting with fat side down. After each stage, turn roast over and shield the warm portions with aluminum foil. Let stand, covered, for 30 to 60 minutes.
8. CASSEROLE/SOUP	1 - 8 cups	After audible signal, stir if possible. At end, stir well and let stand, covered, for 5 to 10 minutes.

**NOTE:**

Check foods when oven signals. After final stage, small sections may still be icy. Let stand to continue thawing. Do not defrost until all ice crystals are thawed.

Shielding prevents cooking from occurring before the center of the food is defrosted. Use small smooth strips of aluminum foil to cover edges and thinner sections of the food.

## OTHER COOKING FEATURES

### BEVERAGE

BEVERAGE enables you to SENSOR REHEAT coffee or tea to a more suitable drinking temperature or to make instant coffee or tea.

- Suppose you want to SENSOR REHEAT 2 cups of coffee.

PROCEDURE	DISPLAY
<b>1</b> <span style="border: 1px solid black; padding: 2px;">BEVERAGE</span> Touch <b>BEVERAGE</b> pad.	<div style="border: 1px solid black; padding: 2px; display: inline-block; margin-bottom: 5px;">SEE LABEL</div> <div style="display: flex; justify-content: space-around;"> <div style="border: 1px solid black; padding: 2px; margin-right: 5px;">SELECT FOOD</div> <div style="border: 1px solid black; padding: 2px;">NUMBER</div> </div>
<b>2</b> <span style="border: 1px solid black; padding: 2px;">2</span> Select desired <b>BEVERAGE</b> setting by touching number pad. (Ex: Touch number <span style="border: 1px solid black; border-radius: 50%; padding: 0 2px;">2</span> pad to SENSOR REHEAT coffee)  <span style="border: 1px solid black; padding: 2px;">2</span> x 4 Enter quantity by touching same number pad <span style="border: 1px solid black; border-radius: 50%; padding: 0 2px;">2</span> repeatedly. (Ex: Touch number <span style="border: 1px solid black; border-radius: 50%; padding: 0 2px;">2</span> pad 4 times)	<div style="border: 1px solid black; padding: 2px; display: inline-block; margin-bottom: 5px;">SENSOR REHEAT</div> <div style="display: flex; justify-content: space-around;"> <div style="border: 1px solid black; padding: 2px; margin-right: 5px;">CONTINUE</div> <div style="border: 1px solid black; padding: 2px;">PRESSING 2</div> </div>  <div style="border: 1px solid black; padding: 2px; display: inline-block; margin-bottom: 5px;">FOR CUPS</div> <div style="display: flex; justify-content: space-around;"> <div style="border: 1px solid black; padding: 2px; margin-right: 5px;">2 CUPS</div> <div style="border: 1px solid black; padding: 2px;">PRESS START</div> </div>
<b>3</b> <span style="border: 1px solid black; padding: 2px;">START</span> Touch <b>START</b> pad.	

**NOTE:**

1. BEVERAGE can be programmed with More or Less Time Adjustment. Touch the **POWER LEVEL** pad once or twice after selecting the amount. See page 24.
2. Touch **HELP MENU** pad when the HELP indicator is lighted in the display, for a helpful hint.
3. More or less than the quantity listed in the chart should be made following the guidelines in any microwave book.

### BEVERAGE CHART

1. COFFEE OR TEA	1 - 4 cups	Use this setting for heating COLD TAP WATER to a temperature somewhat below the boiling point to make instant coffee or tea. Touch number <span style="border: 1px solid black; border-radius: 50%; padding: 0 2px;">1</span> pad for 1 cup increase per touch. Stir liquid briskly before and after heating to avoid 'eruption'.
2. TO SENSOR REHEAT BEVERAGE	.5 - 2.0 cups	This setting is good for restoring cooled beverage to a better drinking temperature. Touch number <span style="border: 1px solid black; border-radius: 50%; padding: 0 2px;">2</span> pad for a 0.5 cup increase per touch. Stir after heating.



## OTHER CONVENIENT FEATURES

### KEEP WARM

KEEP WARM allows you to keep food warm up to 30 minutes.

To use, simply touch the **KEEP WARM** pad and enter the appropriate time (up to 30 minutes). You can also program KEEP WARM with manual cooking to keep food warm continuously after cooking.

#### DIRECT USE

- Suppose you want to keep a cup of soup warm for 15 minutes.

PROCEDURE	
<b>1</b> Touch <b>KEEP WARM</b> pad.	
Enter desired time.	
<b>2</b> Touch <b>START</b> pad.	
The oven will start automatically. The display will show  and count down.  will appear in the display every 10 seconds.	

#### WITH MANUAL COOKING

- Suppose you want to cook a cup of soup for 2 minutes at 70% and keep the soup warm for 15 minutes.

PROCEDURE	
<b>1</b> Enter cooking time.	
<b>2</b> Touch <b>POWER LEVEL</b> pad 4 times for 70% power.	
<b>3</b> Touch <b>KEEP WARM</b> pad.	
Enter desired time.	
<b>4</b> Touch <b>START</b> pad.	
The operation will start. When the cooking time is complete, a long tone will sound and KEEP WARM will start.  will appear in the display every 10 seconds and count down for 15 minutes.	

#### NOTE:

1. To use KEEP WARM after previous cooking has ended, touch **KEEP WARM** pad within 3 minutes after cooking, closing the door or touching the **STOP/CLEAR** pad.
2. KEEP WARM cannot be programmed with SPECIAL FEATURES.

### MULTIPLE SEQUENCE COOKING

Your oven can be programmed for up to 4 automatic cooking sequences, switching from one power level setting to another automatically.

Sometimes cooking directions tell you to start on one power level and then change to a different power level. Your oven can do this automatically.

- Suppose you want to cook roast beef for 5 minutes at 100% and then continue to cook for 30 minutes at 50%.

PROCEDURE	
<b>1</b> First enter cooking time. Then touch <b>POWER LEVEL</b> pad for 100% power.	 
<b>2</b> Then enter second cooking time. Touch <b>POWER LEVEL</b> pad 6 times for 50% power.	 
<b>3</b> Touch <b>START</b> pad.	

#### NOTE:

1. If 100% is selected as the final sequence, it is not necessary to touch the POWER LEVEL pad.
2. If you wish to know power level, simply touch the **POWER LEVEL** pad. As long as your finger is touching the POWER LEVEL pad, the power level will be displayed.
3. KEEP WARM can be programmed continuously even if 4 cooking sequences have been set.

### MORE OR LESS TIME ADJUSTMENT

Should you discover that you like any of the SENSOR or Other Cooking Features (except for DINNER MENU and QUICK RECIPES) settings slightly **more** done, touch the **POWER LEVEL** pad once before touching the **START** pad.

The display will show .

Should you discover that you like any of the SENSOR or Other Cooking Features (except for DINNER MENU and QUICK RECIPES) settings slightly **less** done, touch the **POWER LEVEL** pad twice before touching the **START** pad.

The display will show .

## OTHER CONVENIENT FEATURES

### HELP MENU

HELP MENU provides 5 features which make using your oven easy because specific instructions are provided in the interactive display.

#### 1. CHILD LOCK

The Child Lock prevents unwanted oven operation such as by small children. The oven can be set so that the control panel is deactivated or locked.

To set, touch **HELP MENU**, the number ① and **START** pads. Should a pad be touched, **CHILD** **LOCK** will appear in the display.

To cancel, touch **HELP MENU** and **STOP/CLEAR** pads.

#### 2. AUDIBLE SIGNAL ELIMINATION

If you wish to have the oven operate with no audible signals, touch **HELP MENU**, the number ② and **STOP/CLEAR** pads.

To cancel and restore the audible signal, touch **HELP MENU**, the number ② and **START** pads.

#### 3. AUTO START

If you wish to program your oven to begin cooking automatically at a designated time of day, follow this procedure:

- Suppose you want to start cooking a stew for 20 minutes on 50% at 4:30. Before setting, check to make sure the clock is showing the correct time of day.

PROCEDURE	
<b>1</b> Touch <b>HELP MENU</b> pad.	<b>HELP MENU</b>
<b>2</b> Touch number ③.	<b>3</b>
<b>3</b> Enter the start time.	<b>4 3 0</b>
<b>4</b> Touch <b>TIMER/ CLOCK</b> pad.	<b>TIMER CLOCK</b>
<b>5</b> Enter cooking program.	<b>2 0 0 0</b> <b>POWER LEVEL</b> x 6
<b>6</b> Touch <b>START</b> pad.	<b>START</b>

#### NOTE:

- Auto Start can be used for manual cooking if clock is set.

- If the oven door is opened after programming Auto Start, it is necessary to touch the **START** pad for Auto Start time to appear in the readout so that the oven will automatically begin programmed cooking at the chosen Auto Start time.
- Be sure to choose foods that can be left in the oven safely until the Auto Start time. Acorn or butternut squash are often a good choice.
- If you wish to know the time of day, simply touch the **CLOCK** pad. As long as your finger is touching the **CLOCK** pad, the time of day will be displayed.

#### 4. LANGUAGE / WEIGHT SELECTION

The oven comes set for English and US Customary Unit-pounds. To change, touch **HELP MENU** and the number ④ pads. Continue to touch the number ④ pad until your choice is selected from the table below. Then, touch **START** pad.

Touch number ④ pad for language and standard of weight.

NUMBER	LANGUAGE	STANDARD OF WEIGHT	DISPLAY
Once	English	LBS	ENGLISH LB
Twice	English	KG	ENGLISH KG
3 times	Spanish	LBS	ESPANOL LB
4 times	Spanish	KG	ESPANOL KG
5 times	French	LBS	FRANCAIS LB
6 times	French	KG	FRANCAIS KG

#### 5. CLOCK ON/OFF

If you wish to turn the clock display off, touch **HELP MENU**, the number ⑤ and **STOP/CLEAR** pads.

To cancel and restore the clock, touch **HELP MENU**, the number ⑤ and **START** pads.









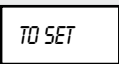

#### HELP

Each setting of SENSOR provides a cooking hint. If you wish to check, touch **HELP MENU** pad whenever HELP is lighted in the Interactive Display for these hints.

## OTHER CONVENIENT FEATURES

### TIMER/CLOCK

- Suppose you want to time a 3-minute long distance phone call.

PROCEDURE		DISPLAY	
<b>1</b>	 Touch <b>TIMER/CLOCK</b> pad.		 
<b>2</b>	 Touch number ① pad.		
<b>3</b>	 Enter time.		
<b>4</b>	 Touch <b>TIMER/CLOCK</b> pad. The Timer will count down.		
<b>5</b>	After the Timer cycle ends, the display will indicate the following message.		

#### NOTE:

To cancel the Timer during programming, touch the **STOP/CLEAR** pad.

### EXTRA MINUTE

EXTRA MINUTE allows you to cook for a minute at 100% by simply touching the **EXTRA MINUTE** pad. You can also extend cooking time in multiples of 1 minute by repeatedly touching the **EXTRA MINUTE** pad during manual cooking.

- Suppose you want to heat a cup of soup for 1 minute.

PROCEDURE	
Touch <b>EXTRA MINUTE</b> pad.	

#### NOTE:

- To use EXTRA MINUTE, touch pad within 1 minute after cooking, closing the door, touching the **STOP/CLEAR** pad or during cooking.
- EXTRA MINUTE cannot be used with SENSOR, Other Cooking Features or KEEP WARM.

### START

START allows you to cook at 100% power by touching the **START** pad continuously. START is ideal for melting cheese, bringing milk to just below boiling etc. The maximum cooking time is 3 minutes.



- Suppose you want to melt cheese on a piece of toast.

PROCEDURE	
<b>1</b>	Continuously touch <b>START</b> pad. The cooking time will begin counting up. 
<b>2</b>	When the cheese is melted to desired degree, remove finger from <b>START</b> pad. Oven stops immediately.

#### NOTE:

- Note time it takes for frequently used foods and program that time in the future.
- Touch **START** pad within 3 minutes after cooking, opening and closing the door or touching the **STOP/CLEAR** pad.
- START can only be used 3 times in a row. If more times are needed, open and close door or touch **STOP/CLEAR** pad.

### DEMONSTRATION MODE

To demonstrate, touch **TIMER/CLOCK**, the number ① and then touch **START** pad and hold for 3 seconds. *DEMO ON DURING DEMO NO OVEN POWER* will appear in the display. Cooking operations and specific special features can now be demonstrated with no power in the oven. For example, touch **EXTRA MINUTE** pad and the display will show  and count down quickly to .

To cancel, touch **TIMER/CLOCK**, then the number ① and **STOP/CLEAR** pads. If easier, unplug the oven from the electrical outlet and replug.

# CLEANING AND CARE

---

Disconnect the power cord before cleaning or leave the door open to inactivate the oven during cleaning.

## Exterior

The outside surface is painted. Clean the outside with mild soap and water; rinse and dry with a soft cloth. Do not use any type of household or abrasive cleaner.

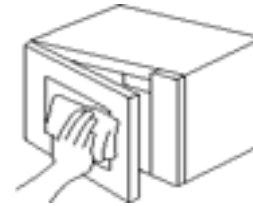

Exterior

## Door

Wipe the window on both sides with a damp cloth to remove any spills or splatters. Metal parts will be easier to maintain if wiped frequently with a damp cloth. Avoid the use of spray and other harsh cleaners as they may stain, streak or dull the door surface.

## Touch Control Panel

Care should be taken in cleaning the touch control panel. If the control panel becomes soiled, open the oven door before cleaning. Wipe the panel with a cloth dampened slightly with water only. Dry with a soft cloth. Do not scrub or use any sort of chemical cleaners. Close door and touch **STOP/CLEAR** pad.

## Interior

Cleaning is easy because little heat is generated to the interior surfaces; therefore, there is no baking and setting of spills or spattering. To clean the interior surfaces, wipe with a soft cloth and warm water. **DO NOT USE ABRASIVE OR HARSH CLEANERS OR SCOURING PADS.** For heavier soil, use baking soda or a mild soap; rinse thoroughly with hot water. **NEVER SPRAY OVEN CLEANERS DIRECTLY ONTO ANY PART OF THE OVEN.**

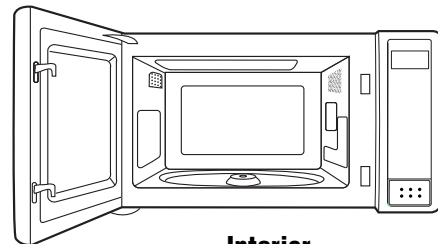

Interior

## Waveguide Cover

The waveguide cover is made from mica so requires special care. Keep the waveguide cover clean to assure good oven performance. Carefully wipe with a damp cloth any food splatters from the surface of the cover immediately after they occur. Built-up splashes may overheat and cause smoke or possibly catch fire. Do not remove the waveguide cover.

## Odor Removal

Occasionally, a cooking odor may remain in the oven. To remove, combine 1 cup water, grated peel and juice of 1 lemon and several whole cloves in a 2-cup glass measuring cup. Boil for several minutes using 100% power. Allow to set in oven until cool. Wipe interior with a soft cloth.

## Turntable/Turntable Support

The turntable and turntable support can be removed for easy cleaning. Wash them in mild, sudsy water; for stubborn stains use a mild cleanser and non abrasive scouring sponge. They are also dishwasher-proof. Use upper rack of dishwasher. The turntable motor shaft is not sealed, so excess water or spills should be wiped up immediately.



Turntable



Turntable Support

## SPECIFICATIONS

---

AC Line Voltage:	Single phase 120V, 60Hz, AC only
AC Power Required:	1650 watts, 13.8 amps.
Output Power: Microwave	1200 watts* (IEC Test Procedure)
Frequency:	2450 MHz
Outside Dimensions:	24"(W) x 13 3/8"(H) x 19 1/8"(D)
Cavity Dimensions:	17 3/8"(W) x 10 1/2"(H) x 18 5/8"(D)
Oven Capacity:	2.0 Cu. Ft.
Cooking Uniformity:	Turntable system
Weight:	Approx. 46 lb

★ The International Electrotechnical Commission's standardized method for measuring output wattage. This test method is widely recognized.

In compliance with standards set by:

**FCC** – Federal Communications Commission Authorized.

**DHHS** – Complies with Department of Health and Human Services (DHHS) rule, CFR, Title 21, Chapter I, Subchapter J.



– This symbol on the nameplate means the product is listed by Underwriters Laboratories, Inc.

## SERVICE CALL CHECK

---

Please check the following before calling for service:

Place one cup of water in a glass measuring cup in the oven and close the door securely.  
Operate the oven for one minute at HIGH 100%.

- |          |  |           |          |
|----------|--|-----------|----------|
| <b>A</b> | Does the oven light come on?   | YES _____ | NO _____ |
| <b>B</b> | Does the cooling fan work?<br>(Put your hand over the rear ventilating openings)           | YES _____ | NO _____ |
| <b>C</b> | Does the turntable rotate?<br>(It is normal for the turntable to turn in either direction) | YES _____ | NO _____ |
| <b>D</b> | Is the water in the oven warm?   | YES _____ | NO _____ |

**If 'NO' is the answer to any of the above questions, check electrical outlet, fuse and/or circuit breaker. If they are functioning properly, contact Customer Care. For contact details, see your Service & Warranty booklet or visit our website [www.fisherpaykel.com](http://www.fisherpaykel.com).**

**A microwave oven should never be serviced by a 'do-it-yourself' repair person.**

**NOTE:**

If time appearing in the display is counting down very rapidly, check Demonstration Mode on page 26 and cancel.

## WARRANTY

---



**See your Service & Warranty booklet for warranty details.**

# CONTROL PANEL GUIDE

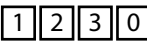

For more complete information and safety precautions, refer to your Operation Manual.

### SET CLOCK

If *WELCOME PRESS CLEAR AND PRESS CLOCK* is in the display, first touch **STOP/CLEAR**.



- 1 Touch **TIMER/CLOCK** pad and number ②. 
- 2 Enter correct time of the day by touching numbers in sequence. (Ex: 12:30) 
- 3 Touch **TIMER/CLOCK** pad again. 

### SENSOR

- 1 Touch **BAKED POTATOES** pad. 
- 2 Press **START**. 

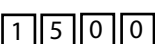

FOOD	AMOUNT
POPCORN	1 package 1.5 - 3.5 oz
SENSOR REHEAT	4 - 36 oz
FRESH VEGETABLES:	
Soft	.25 - 2.0 lb
Hard	.25 - 1.5 lb
RICE	.5 - 2.0 cups
BAKED POTATOES	1 - 8 med.
GROUND MEAT	.25 - 2.0 lb
POULTRY:	
Boneless	.5 - 2.0 lb
Bone-in	.5 - 3.0 lb
FISH/SEAFOOD	.25 - 2.0 lb
FROZEN ENTREES	6 - 17 oz
FROZEN SNACKS	3 - 8 oz
FROZEN VEGETABLES	.25 - 1.5 lb

### KEEP WARM



- 1 Touch **KEEP WARM** pad. 
- 2 Enter the desired time up to 30 minutes. (Ex: 15 minutes) 
- 3 Touch **START** pad. 

### MANUAL OPERATION





#### HIGH POWER COOKING

- 1 Enter cooking time by touching number pads. (Ex: 1 min. 30 sec.) 
- 2 Touch **START** pad. 

#### VARIABLE POWER COOKING

- 1 After Step 1 above, touch **POWER LEVEL** pad six times for 50%. 
- 2 Touch **START** pad. 

### DEFROST

- 1 Touch **DEFROST** pad. 
- 2 Select desired food. (Ex: touch the number ⑤ pad to defrost Steak.) 
- 3 Touch number pads ② and ① for 2.0 lb. (Ex: 2.0 lb steak.) 
- 4 Touch **START** pad. During defrosting, the oven will stop; follow the directions. Touch **START** pad to continue defrosting. 

FOOD	AMOUNT
<b>SUPER DEFROST</b>	
1. GROUND MEAT	1.0 lb
2. BONELESS POULTRY	1.0 lb
3. BONE-IN CHICKEN PIECES	2.0 lb
<b>DEFROST</b>	
4. GROUND MEAT	.5 - 3.0 lb
5. STEAKS CHOPS OR FISH	.5 - 4.0 lb
6. CHICKEN PIECES	.5 - 3.0 lb
7. ROAST	2.0 - 4.0 lb
8. CASSEROLE/SOUP	1 - 8 cups

### EXTRA MINUTE

Touch **EXTRA MINUTE** for one minute at 100% power or to add a minute during manual cooking. Continue to touch for additional minutes. 

Continued on page 31.

# CONTROL PANEL GUIDE

## BREAKFAST MENU

- 1 Touch **BREAKFAST MENU** pad. BREAKFAST MENU
- 2 Select desired food.  
(Ex: touch the number ③ pad for hot cereal.) 3
- 3 Touch number ② pad for 2 servings. 2
- 4 Touch **START** pad. START

FOOD	AMOUNT
1. SCRAMBLED EGGS	1 - 9 eggs
2. BACON	2 - 6 slices
3. HOT CEREAL	1 - 6 servings
4. HEAT ROLLS/MUFFINS	1 - 10 pieces
5. FROZEN BREAKFAST FOODS	1 (3 - 6 oz)

## LUNCH MENU

- 1 Touch **LUNCH MENU** pad. LUNCH MENU
- 2 Select desired food.  
(Ex: touch the number ③ pad for soup.) 3
- 3 Touch **START** pad. START

FOOD	AMOUNT
1. MEAL IN A CUP	1 cup (6 - 8 oz)
2. HOT DOGS IN BUNS	1 - 4
3. SOUP	1 - 8 cups
4. MICROWAVE PIZZA	1 (6 - 8 oz)
5. FROZEN SANDWICH	1 (3 - 6 oz)

## BEVERAGE

- 1 Touch **BEVERAGE** pad. BEVERAGE
- 2 Select desired BEVERAGE setting.  
(Ex: touch the number ② pad to SENSOR REHEAT coffee.) 2
- 3 Touch number ② pad 4 times for 2 cups. 2 x 4
- 4 Touch **START** pad. START

FOOD	AMOUNT
1. TO MAKE COFFEE OR TEA	1 - 4 cups
2. TO REHEAT BEVERAGE	.5 - 2.0 cups

## DINNER MENU

- 1 Touch **DINNER MENU** pad. DINNER MENU
- 2 Select desired food.  
(Ex: touch number pad ② for Hawaiian Pork.) 2
- 3 Touch **START** pad. START

## RECIPES

(All are for 6 servings)

**SEE RECIPE CARD FOR DETAILS.**

1. SAUCY CHICKEN	4. GLAZED SALMON
2. HAWAIIAN PORK	5. HEALTHY FRITTATA
3. FIESTA CHILI	

## QUICK RECIPES

- 1 Touch **QUICK RECIPES** pad. QUICK RECIPES
- 2 Select desired recipe. (Ex: touch number ③ pad for Italian Salad.) 3
- 3 Touch **START** pad. START

## RECIPES

(All are for 6 servings)

**SEE RECIPE CARD FOR DETAILS.**

1. BEEF WRAPS	4. TUNA MACARONI
2. MEXICAN CHICKEN	5. GARDEN MEDLEY
3. ITALIAN SALAD	

## START

Continuously touch **START** pad for 100% power cooking. Remove finger and oven will stop instantly. START









**FISHERPAYKEL.COM**

© Fisher & Paykel Appliances 2018. All rights reserved.  
The product specifications in this booklet apply to the specific products and models described at the date of issue. Under our policy of continuous product improvement, these specifications may change at any time. You should therefore check with your Dealer to ensure this booklet correctly describes the product currently available.

**US CA**

**212545C 01.18**